

PRODUCT SHEET

Description:

Electronic Touch Pad Cam Lock, $\varnothing 19 \times 20 \text{mm}$, $\varnothing 55 \text{mm}$, Zamak Knob, Silver/Black, W/USB C Charging Cable, Straight Cam ce: 39,5mm,, 90 Degree Turn, W/Build-in Lithium Battery, Public/Private

Item number:

14.60.470-0

Units	Box	Carton	HS Code	Barcode
Pcs.			8301300000	
				5704866523226

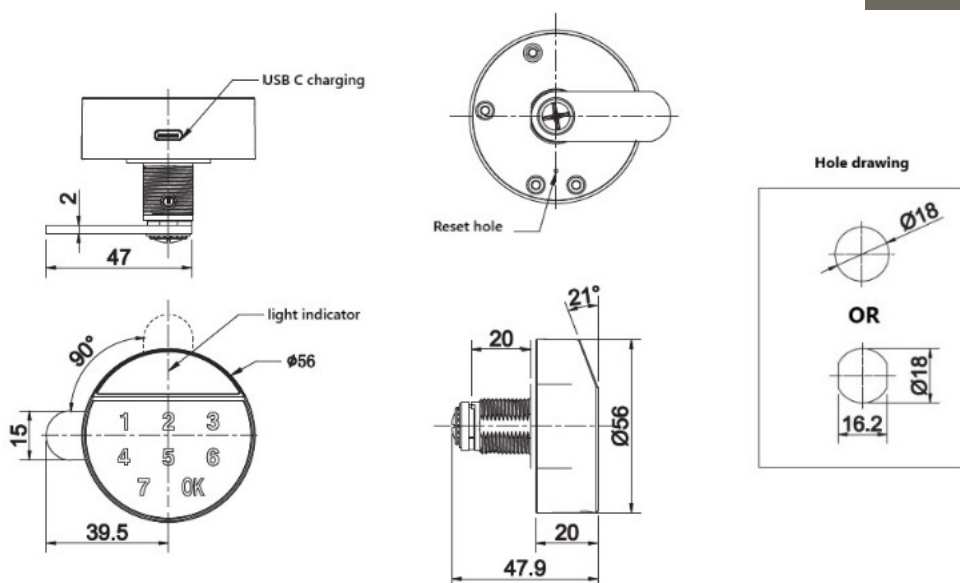

SISO A/S

Mileparken 11
DK-2740 Skovlunde
Denmark
VAT: 24786013

Phone +45 45 830 900

www.siso.dk
siso@siso.dk

Danske Bank
Nytorv Branch
Copenhagen
SWIFT: DABADKKK

Account no.
4180 3112 112936
IBAN Account
DK7230003112112936